

Colonne

(CM.10)

(CM.46)

(CM.36)



ART 733

(CM.13)

(CM.49)

(CM.37)



ART 736

(CM.3)

(CM.30)

(CM.200)

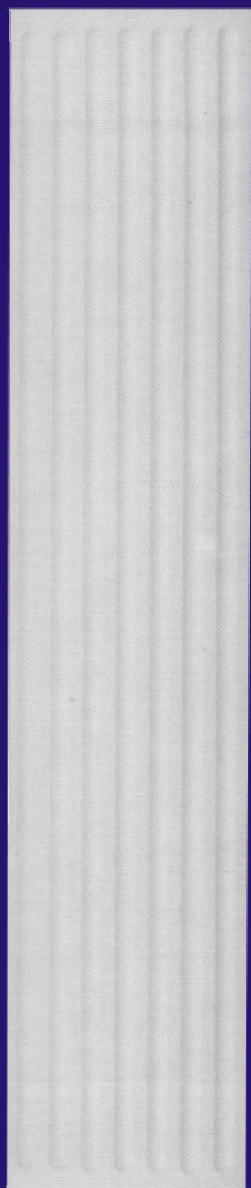

ART 734

(CM.3)

(CM.30)

(CM.200)



ART 734

(CM.9)

(CM.26)

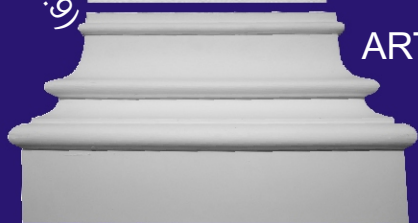

ART 735

(CM.43)

(CM.9)

(CM.26)



ART 735

(CM.43)

Colonne

(CM.14)

(CM.68)



(CM.56)

ART 737

(CM.14)

(CM.68)



(CM.47)

ART 740

(CM.3)
(CM.40)

(CM.200)

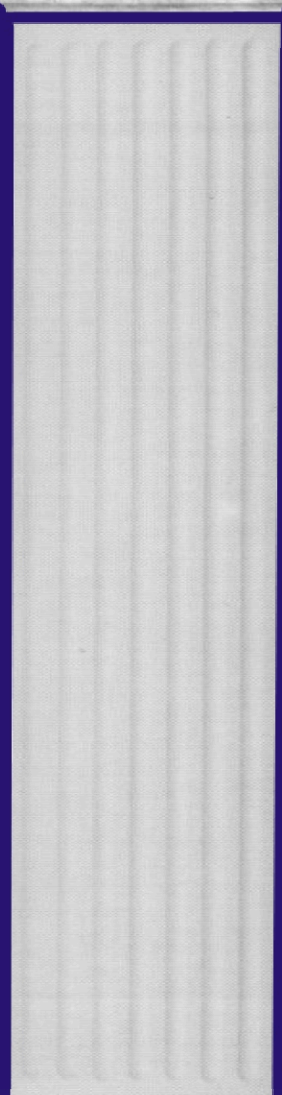

ART 738

(CM.2)
(CM.45)

(CM.200)



ART 741

(CM.9)

(CM.26)

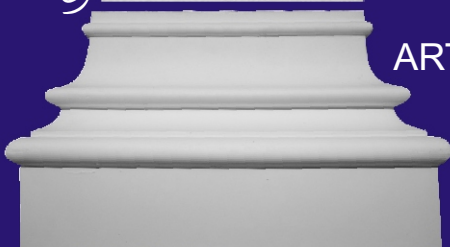

ART 739

(CM.53)

(CM.9)

(CM.26)



ART 742

(CM.58)

Colonne

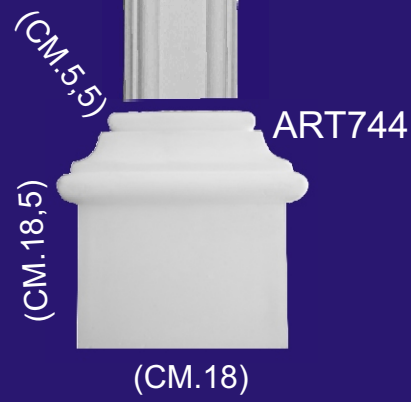
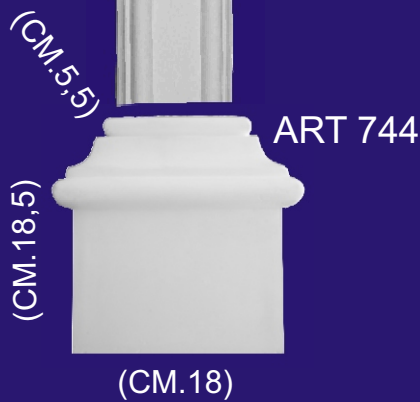
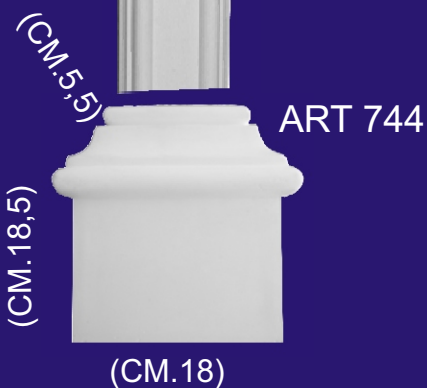
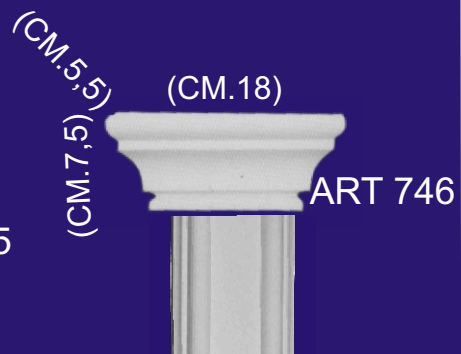

Colonne

(CM.1,5)

(CM.3)



ART 390

ASTA CM.180

(CM.2,5)

(CM.5)



ART 389

ASTA CM.180

(CM.4)

(CM.8)



ART 388

ASTA CM.200

(CM.5)

(CM.10)



ART 387

ASTA CM.200

(CM.6)

(CM.12)

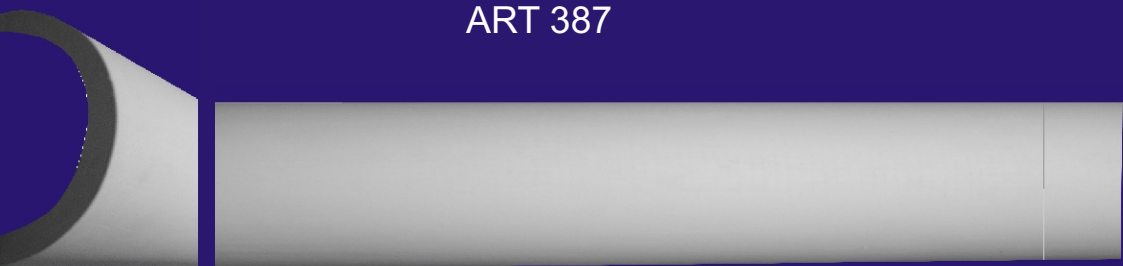

ART 386

ASTA CM.200

(CM.7,5)

(CM.15)

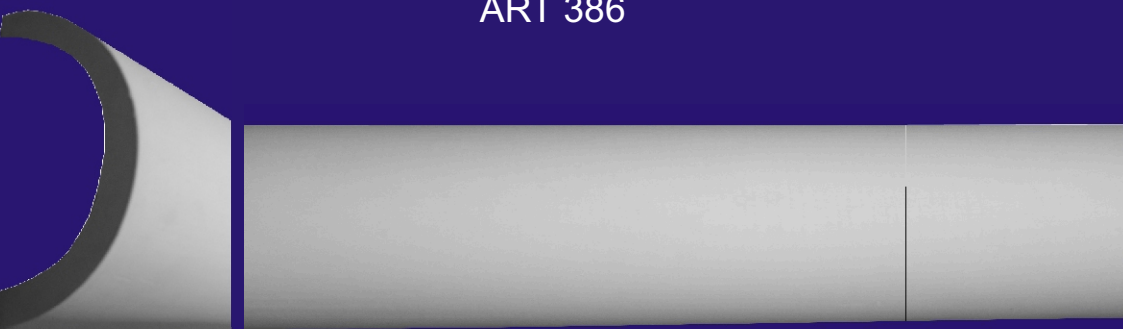

ART 385

ASTA CM.200

(CM.10)

(CM.20)



ART 380

ASTA CM.200

196



(CM.12,5)

(CM.25)

ART 544

ASTA CM.200



(CM.15)

(CM.30)

ART 565

ASTA CM.200

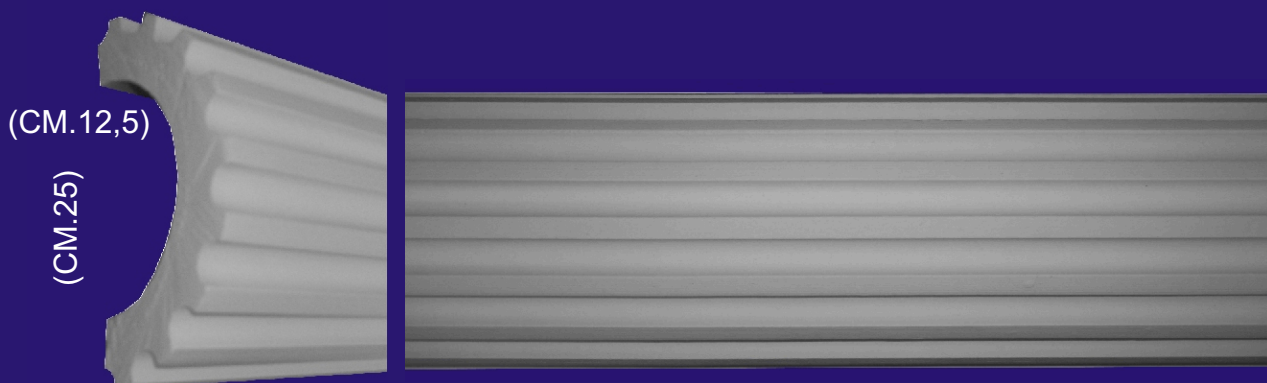

(CM.12,5)

(CM.25)

ART 542

ASTA CM.200

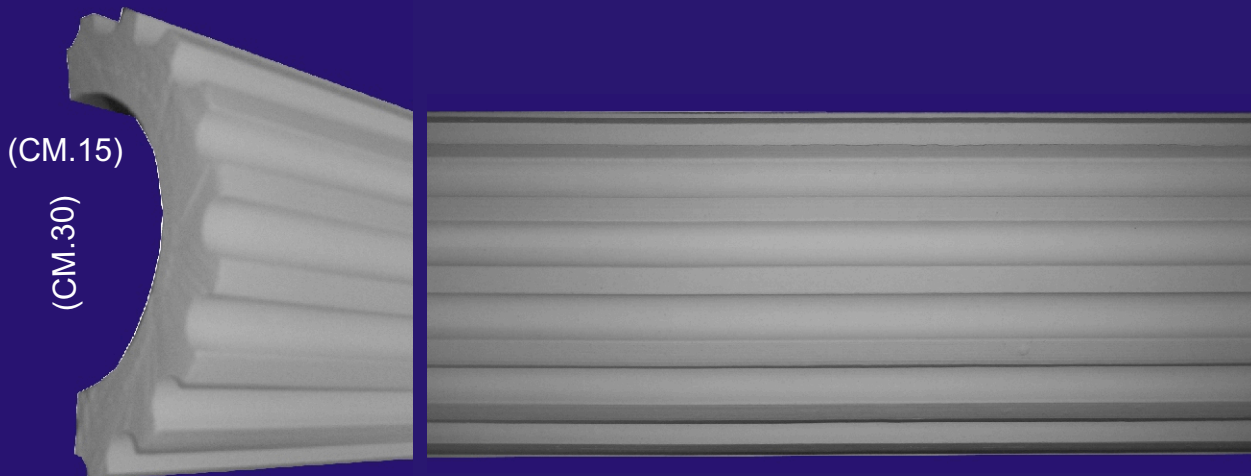

(CM.15)

(CM.30)

ART 564

ASTA CM.200

(CM.4)

(CM.8)

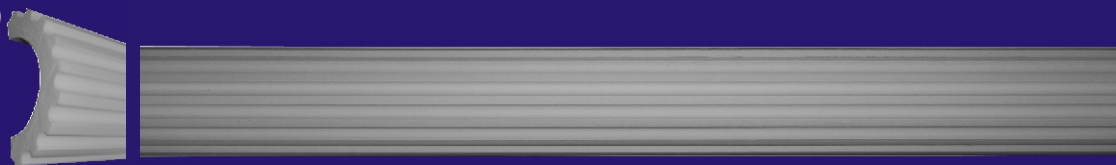

ART 748

ASTA CM 200

(CM.5)

(CM.10)

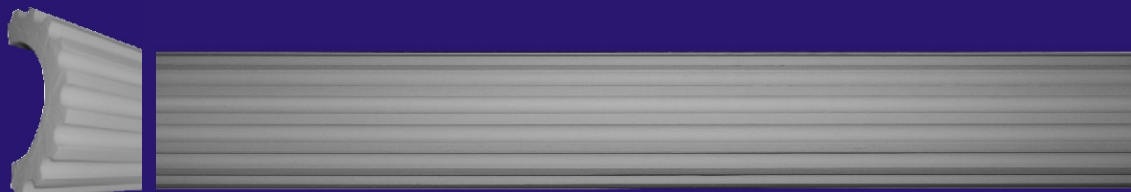

ART 753

ASTA CM.200

(CM.6)

(CM.12)

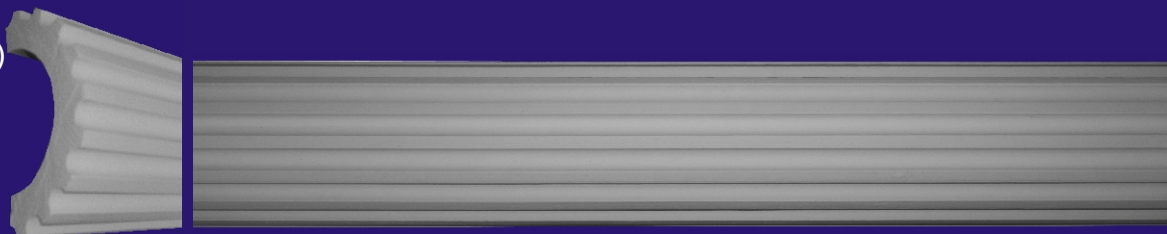

ART 758

ASTA CM.200

(CM.7,5)

(CM.15)

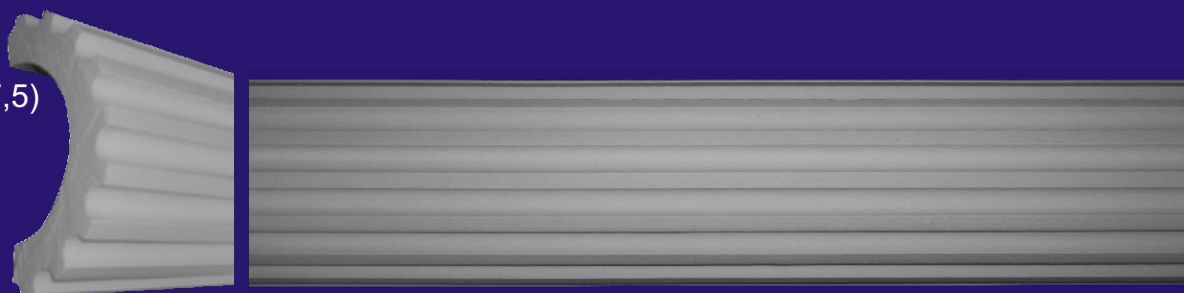

ART 531

ASTA CM.200

(CM.10)

(CM.20)

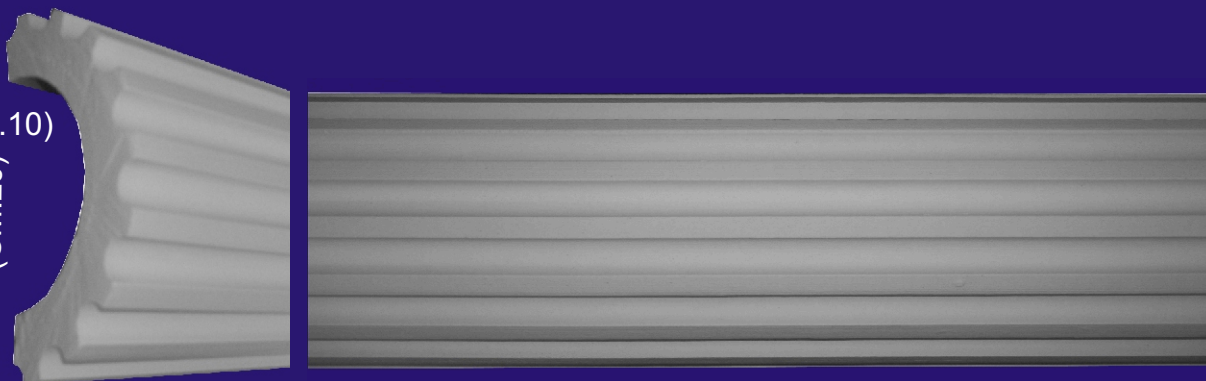

ART 536

ASTA CM.200

Colonne



Colonne

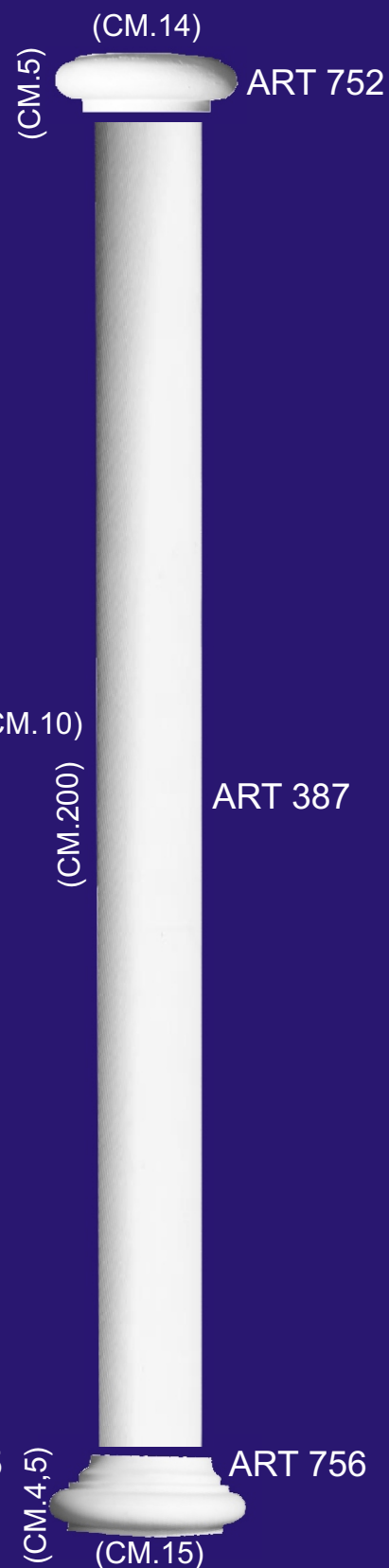
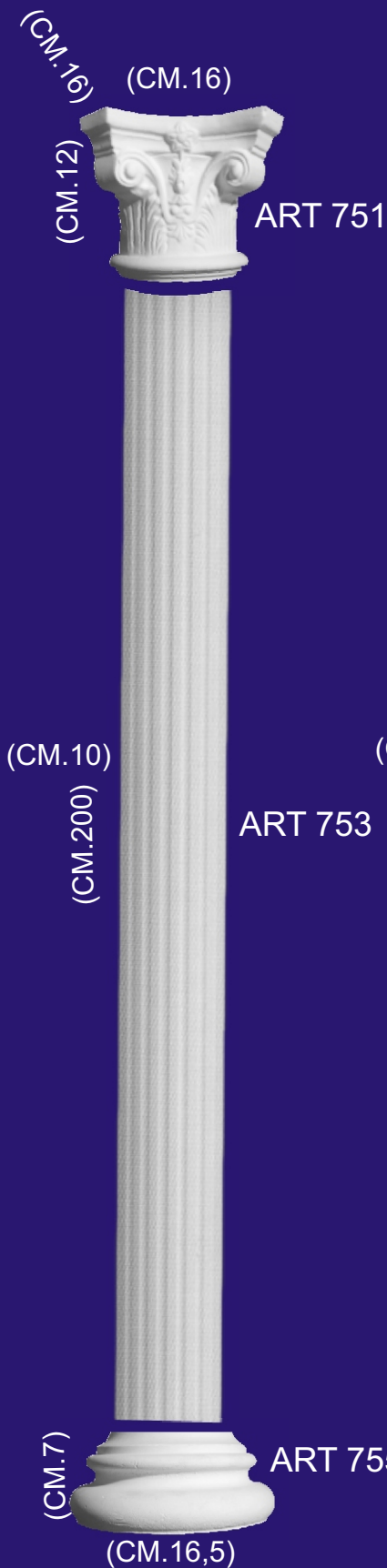
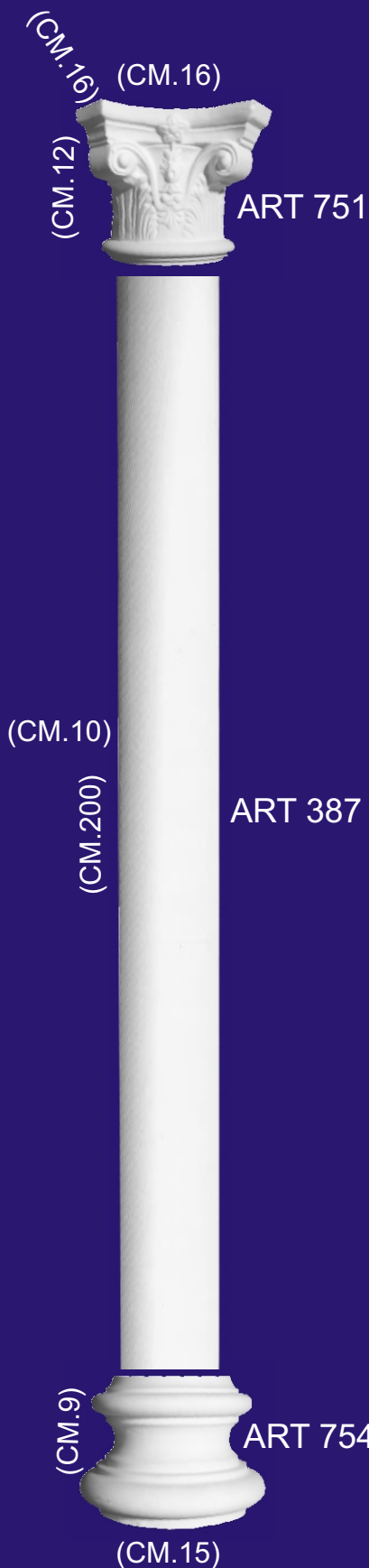

Colonne

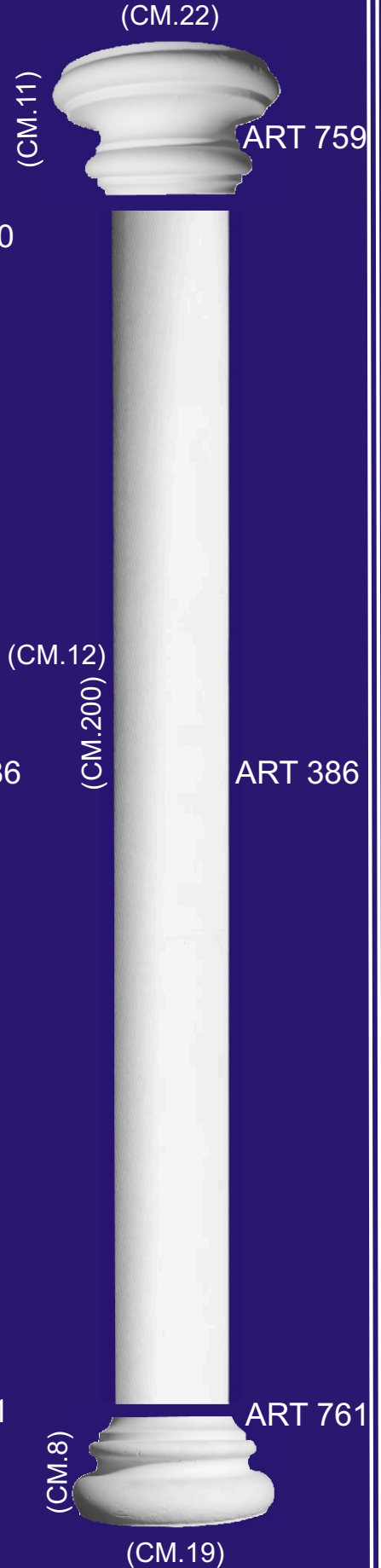
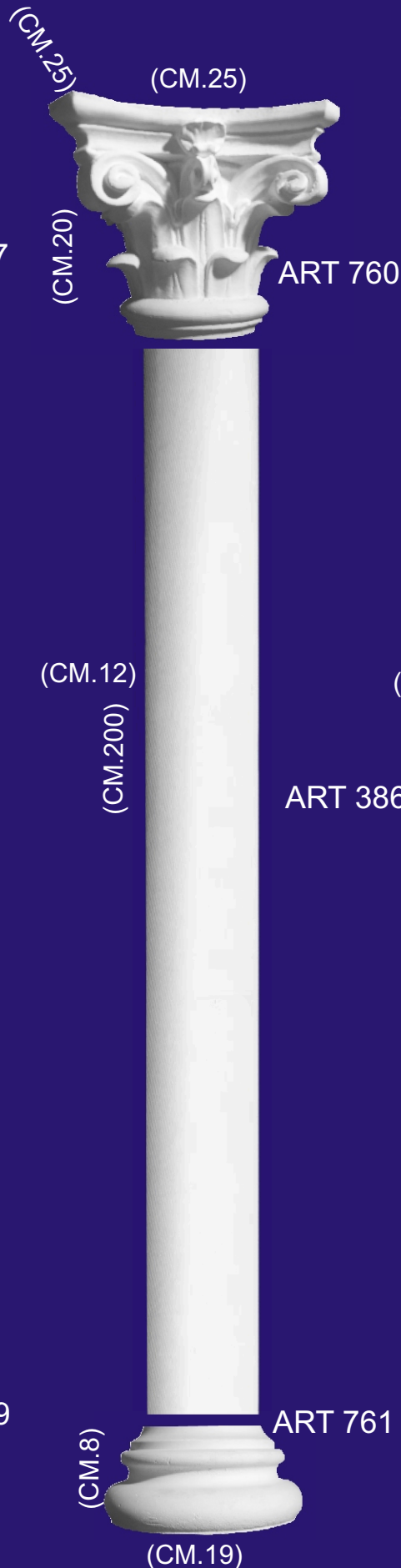
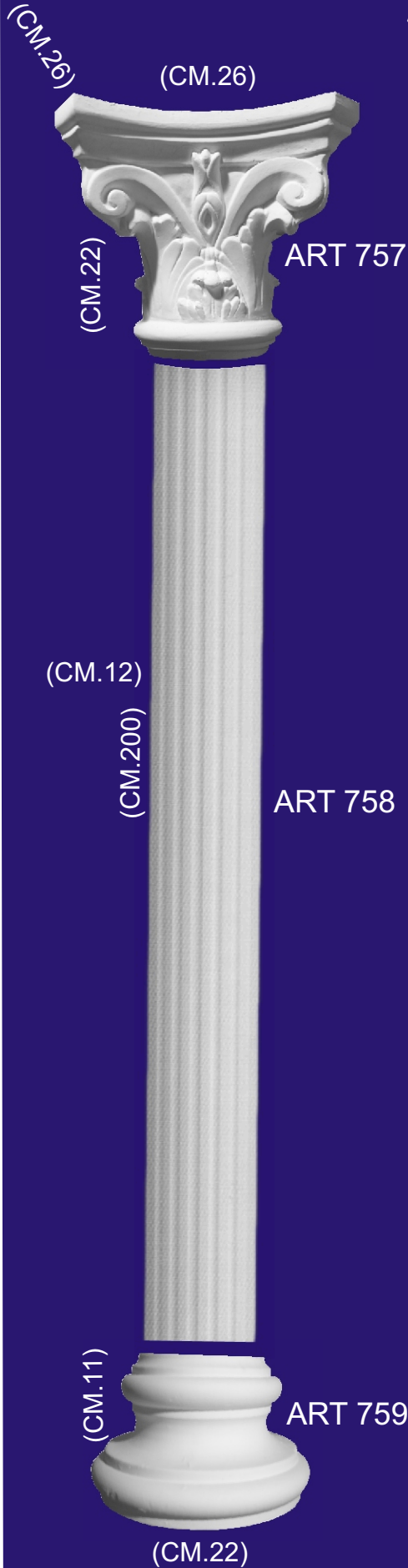

Colonne



ART 530



ART 533

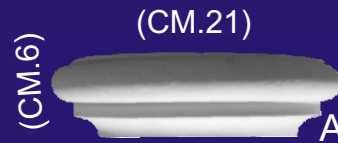

ART 534

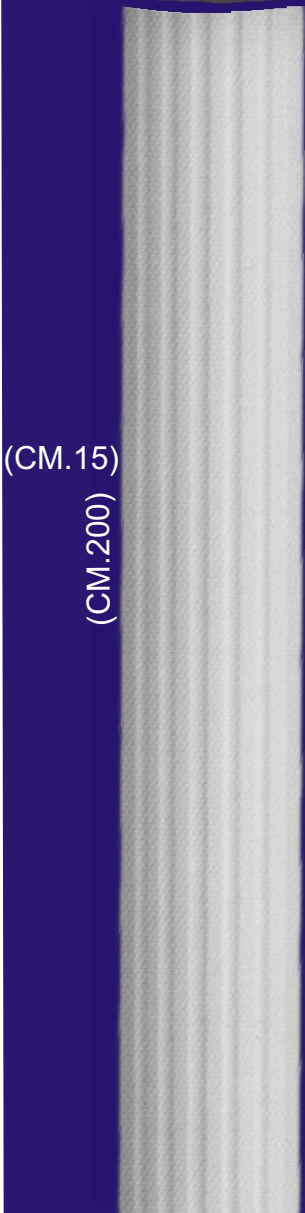

ART 531

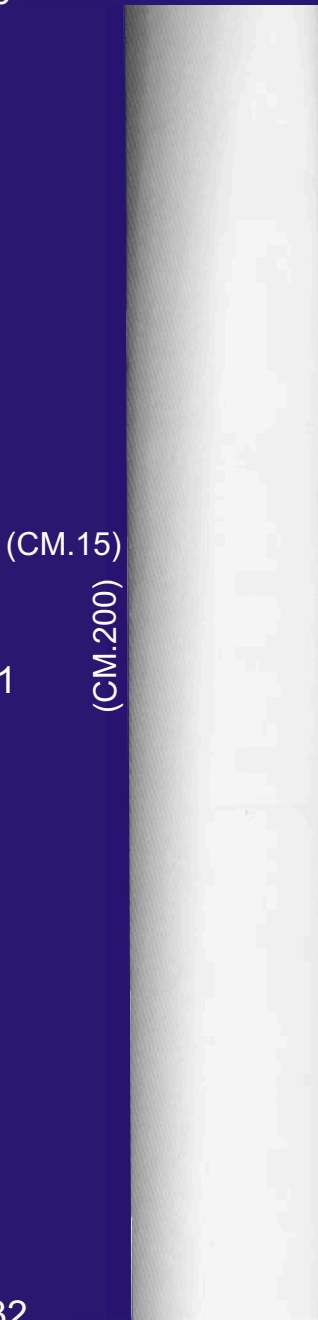

ART 385



ART 385



ART 532



ART 534



ART 532

(CM.23)

(CM.21)

(CM.23)

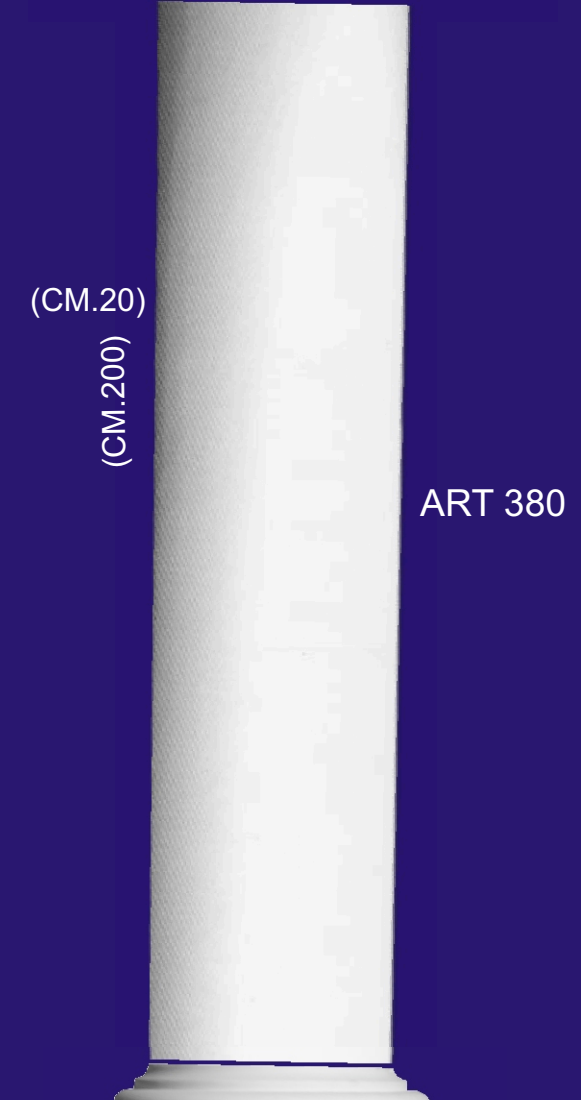
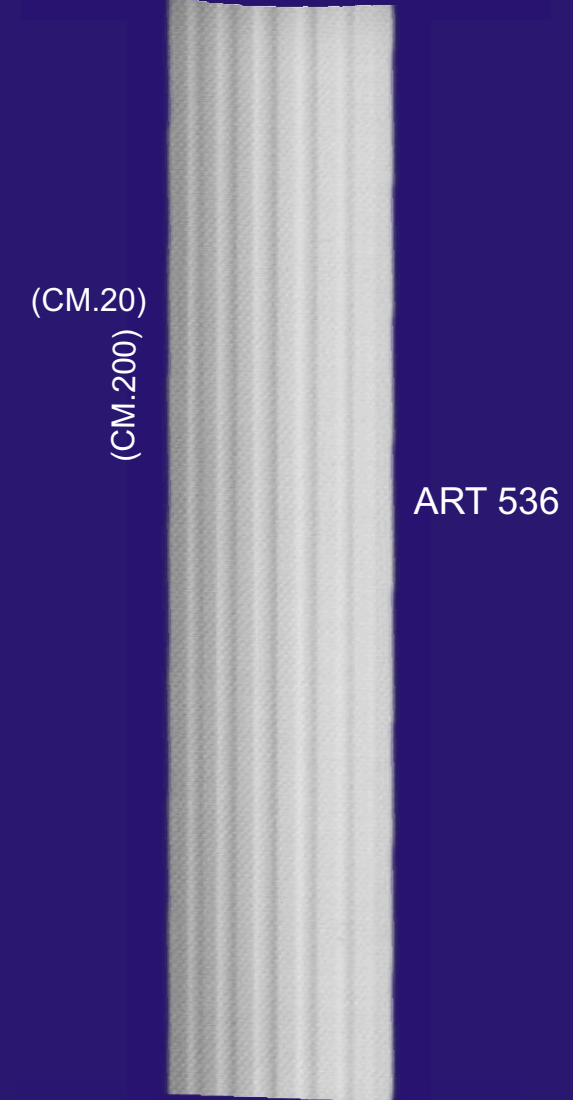

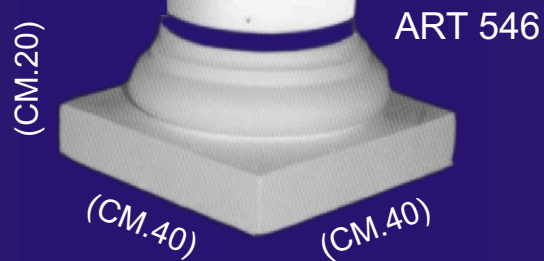
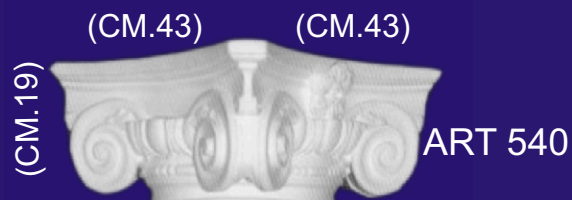
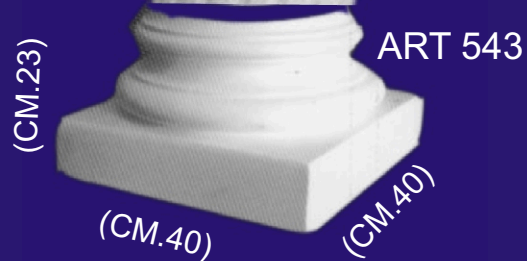
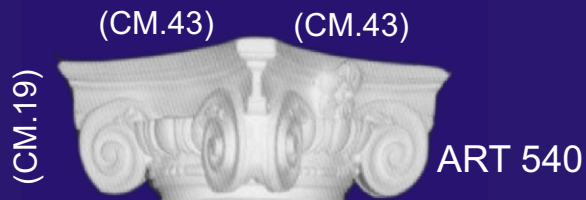

Colonne

